



AUSTRALIA'S LEADING HYDRAULICS COMPANY

www.berendsen.com.au



20+ Years Experience

For over 20 years, Berendsen Fluid Power has been at the forefront of Australia's fluid power industry.



COMPANY SNAPSHOT

Berendsen Fluid Power is Australia's largest locally-owned hydraulic services provider. Our capacity to provide an end-to-end range of products and services suited to well established, multi-site organisations is unparalleled within the fluid power industry.

With nine fully equipped workshops across the country, Berendsen is Australia's largest specialist hydraulic services provider.

Our national footprint allows us to consistently provide high quality services, competitive prices and seamless communications for multi-site organisations.

Our safety systems underpin a high level of safety awareness by staff, organisational standards and training to drive positive outcomes.

Our technical know-how, comprehensive workshop facilities and stringent quality control combine to provide superior life and performance, from turnkey systems to rebuilt cylinders and components.

Supported by our extensive workshop facilities, we maintain a fleet of field service vehicles manned by adaptable and highly skilled technicians who provide emergency response services in addition to planned maintenance services and technical support.



THEN



Berendsen Fluid Power was formed in 1993 through the acquisition of a number of Australian owned hydraulic businesses and soon gained acclaim as Australia's largest independent supplier of power and motion control products and associated services.

In 2000 the company was acquired by new Australian ownership who recognised the market requirement for an end-to-end range of service offerings specifically tailored to the needs of Australia's diverse industry sectors.

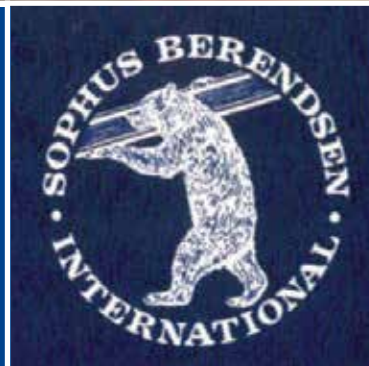



A strategic plan was established and over the ensuing years investments in premises, machinery, engineering software, CAM software, quality systems and personnel development have transformed the company into Australia's leading hydraulics authority.

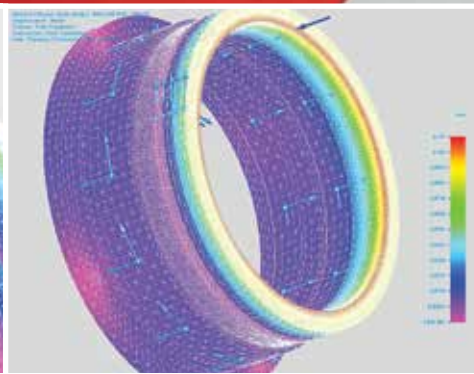
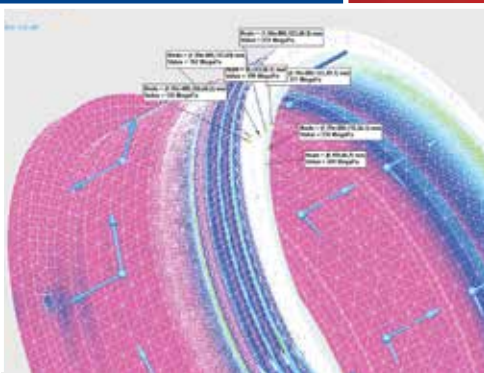

NOW

Why Berendsen?



ISO 9001 certified Australian designer and manufacturer of hydraulic cylinders, manifolds and power units



Tier-one importer and distributor of hydraulic products, direct from manufacturers



Our national network of branches has a successful track record working with large multisite organisations including many iconic Australian brands; BlueScope, Rio Tinto, OneSteel, BHP and Visy



Unrivalled capacity to meet the full spectrum of requirements for both large and small scale users of hydraulic equipment



Strong safety culture and systems audited and accredited for both on-site and off-site works by major clients including Rio Tinto, BlueScope and Broadspectrum



A trustworthy, secure and reliable partner with over 20 years' experience

End-to-End Range of Services

ENGINEERING & DESIGN



SUPPLY



REPAIRS & MAINTENANCE



MANUFACTURING

INSTALLATION & STARTUP





ENGINEERING & DESIGN

Berendsen Fluid Power boasts an in-house engineering and design team of qualified hydraulic engineers and market-leading computer-aided design programs allowing us to provide integrated solutions without the complications of working with third party engineering firms.

Each year Berendsen recruits and engages some of Australia's top Mechanical and Mechatronic Engineering Graduates, providing us with engineering talent that is up to date with international trends and ensuring our know-how remains strong into the future.

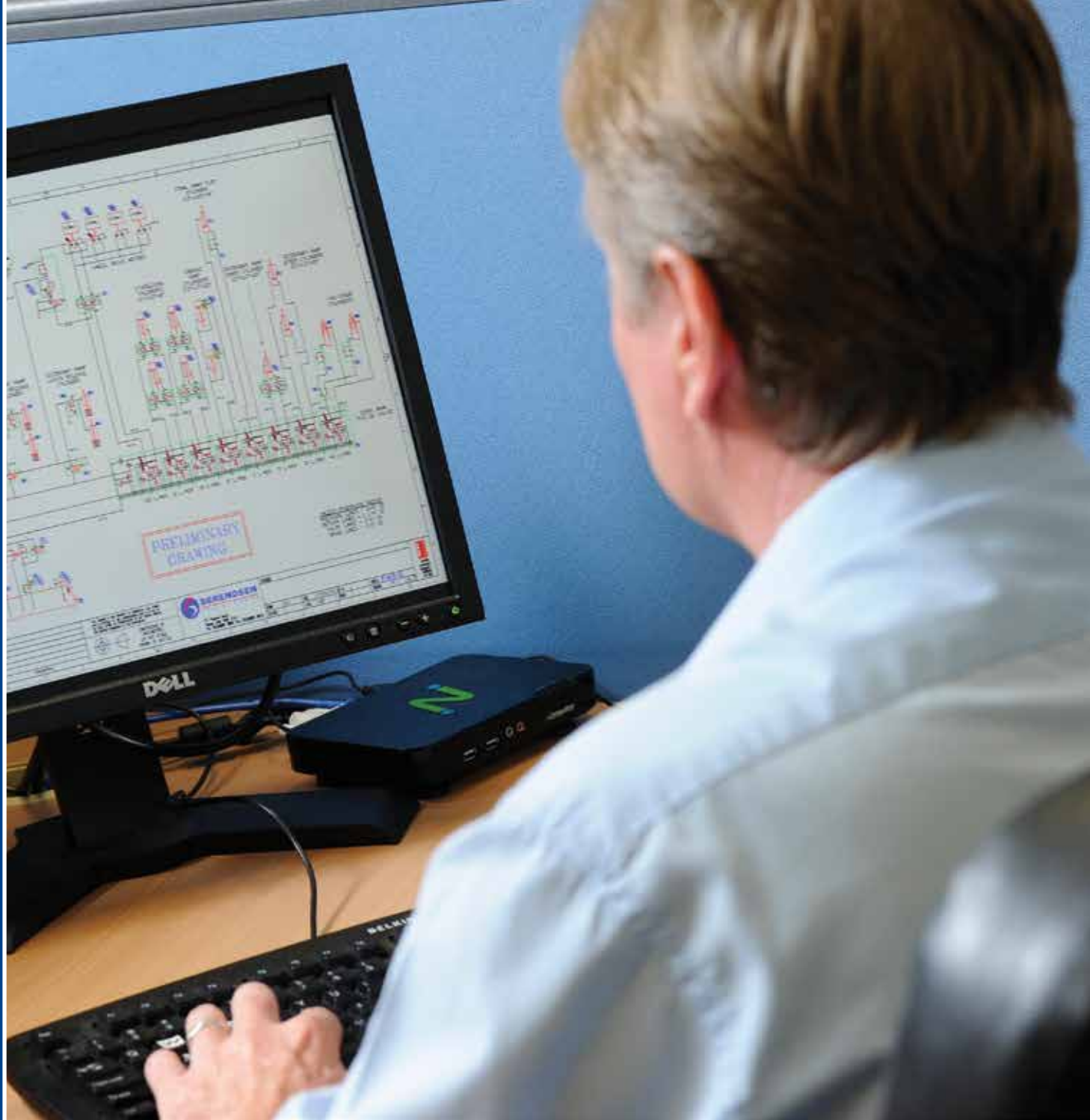

OUR ENGINEERING & DESIGN TOOLS

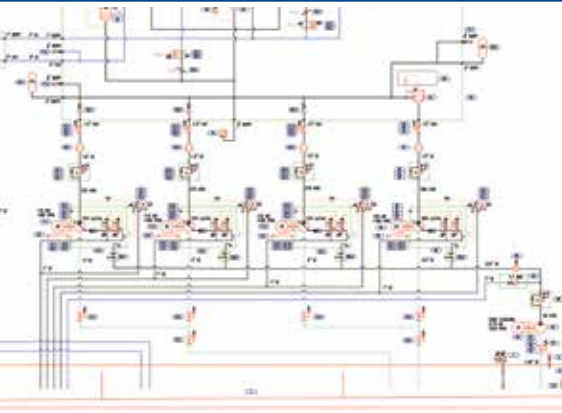

AutoCAD and HydroSym

2D hydraulic schematics and bills of materials are developed using AutoCAD and HydroSym software to represent the components of the hydraulic system and enable development of more complex modelling.

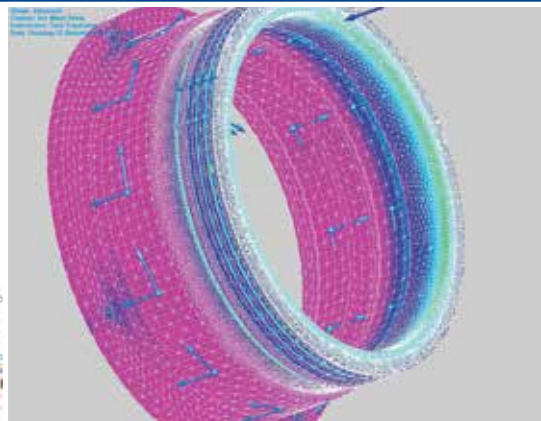

Finite Element Analysis

Using sophisticated simulation software, our in-house engineering department is capable of analysing stress concentrations in manufactured components to predict whether a part will break, wear out or work the way it is intended to when subjected to real world forces. If required, Berendsen's in-house engineers can redesign components to significantly improve the reliability and longevity of cylinders and other equipment.

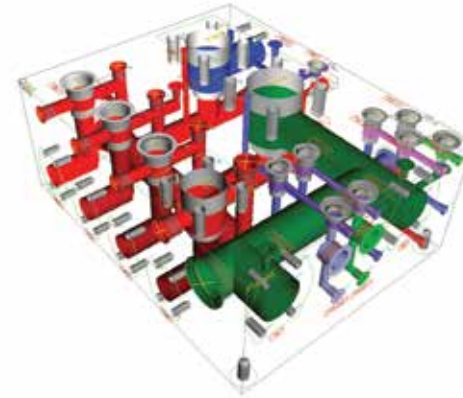

HydroMan

Compact, low-cost hydraulic manifolds are rapidly gaining favour as the preferred technology for power and motion control systems.

HydroMan is a complete 3D hydraulic manifold design software package for the rapid design of complex hydraulic manifolds. It provides an intuitive graphical interface, calculates wall thicknesses and intersection areas, and has a large cartridge valve library, allowing us to produce cost-effective designs with maximum efficiency.



Solid Edge and Xpress Route

Solid Edge is a 3D Modelling and Assembly software package that allows Berendsen to create complex digital prototypes.

New designs can then be reviewed, tested and verified by computer simulation prior to manufacture, ensuring the long-term performance of every component. Xpress Route is an add-on software package used to efficiently produce 3D pipework detail for power unit models.



MANUFACTURING

Berendsen Fluid Power manufactures large-scale hydraulic components at its ISO 9001 accredited, 3200m² facility in Newcastle, NSW. Our manufacturing capabilities encompass all elements of hydraulic systems including large and small-scale cylinders, power units and manifolds.

OUR MANUFACTURED PRODUCTS



Cylinders

Berendsen has carved out a name in Australian industry for the design and manufacture of first-rate hydraulic cylinders. We are particularly well known for our capacity to design and manufacture heavy-duty cylinders for special applications such as underground mining, steel making, heavy mobile equipment and marine applications.

We are one of only a few Australian companies that can design and manufacture very large cylinders such as those used on stacker reclaimers, large excavators, cranes, hay-presses and blast furnaces.

Berendsen also produces a catalogued range of mill type cylinders as well as a range of medium and heavy-duty cylinders of welded construction.

All cylinders are designed and produced from start to finish by Berendsen's ISO accredited cylinder design and manufacturing facility in Newcastle, NSW.



Power Units

Berendsen manufactures a standard range of hydraulic power units with 50, 100 or 200 litre tank capacity and up to 22kW input power. These units were designed with flexibility in mind and are highly customisable due to a unique base manifold design. New builds are typically dispatched within 2 to 3 days from order.

In addition, Berendsen frequently designs and manufactures customised hydraulic power units for special applications. Our solutions driven approach begins with the scope of our customer's requirements being accurately defined by our engineers. Each solution is unique and developed to exact specifications using a combination of design software and application experience supported by hydraulic schematics, GA drawings and engineering calculations.



Manifolds

Compact, low-cost hydraulic manifolds are rapidly gaining favour as the preferred technology for power and motion control systems. Using HydroMan, our complete 3D manifold design software package, Berendsen has the capacity to efficiently design custom hydraulic manifolds to suit any requirement. Our designs are manufactured to exacting standards on state-of-the-art CNC Machining Centres at our ISO accredited manufacturing facility in Newcastle, NSW. We are competitive and flexible, producing large production volumes as well as small batch quantities.



SUPPLY

Berendsen Fluid Power is a tier-one importer of hydraulic components, sourcing leading brands directly from the manufacturing plants. Due to our scale and purchasing power, Berendsen is able to achieve superior cost-to-supply over other hydraulic suppliers.

As part of our commitment to hydraulic component supply we are proud to offer our customers the convenience of our online shop. Our shop makes a large range of competitively priced hydraulic components including cylinders, filters, motors, valves and pumps available online. Visit www.berendsen.com.au.





INSTALLATION & STARTUP

Over more than 20 years, Berendsen has accumulated an impressive portfolio of projects spanning a wide range of industries and applications. Our experienced installation and commissioning teams can be mobilised to remote locations where comprehensive preparation and planning are key to timely fulfilment of project deadlines.



REPAIRS & MAINTENANCE

Berendsen understands that in today's challenging environment, supplying high-quality products and systems is not enough. These must be backed up in the form of expert technical advice, readily available spare parts, specialised repair centres and equipment, mobile service vehicles and the capacity to provide an emergency breakdown response.

All of these facets are available through Berendsen's nationwide branch network and customers have the added peace of mind that each repair and service has passed Berendsen's stringent quality assurance process.

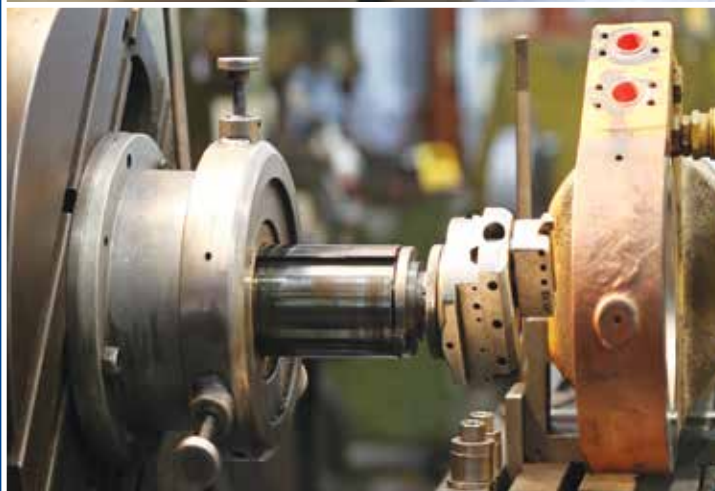

OUR REPAIR AND MAINTENANCE SERVICES



Cylinder Repair

Berendsen customers demand cylinder repairs that last. Our workshops are well equipped with comprehensive facilities including:

- Overhead lifting capacity up to 10 tonne
- Honing of barrels up to 12,000mm and bores up to 500mm
- Nut tensioning up to 90,000 Nm
- Exhaustive range of manual and CNC machines for turning, milling, boring and drilling operations
- Extensive testing facilities compatible with mineral oils and solcenic fluids
- Inhouse hardchrome plating, grinding and lishing facilities

Our intimate knowledge of cylinders and repair standards accumulated over many years have allowed us to develop a rigorous and highly refined cylinder service process.

Expect superior life and performance from our rebuilt cylinders and the reassurance of our comprehensive cylinder repair warranty.



Pump Repair

At Berendsen, we understand how critical it is to reduce equipment downtime and prevent costly shut-downs, so we work fast to get your pumps repaired on time, every time.

Our workshops are well equipped with comprehensive facilities including:

- Dedicated clean room facilities
- Comprehensive test rig facilities
 - Variable speed
 - Open and closed loop testing
 - Up to 350 bar max pressure
 - Up to 500 l/min max flow
 - Up to 200kW power
- Hot-wash, sandblasting and lapping facilities

Berendsen has the capacity to test a comprehensive range of control types. We offer market competitive labour rates and provide comprehensive repair warranties.

OUR REPAIR AND MAINTENANCE SERVICES



Equipment Overhaul

Berendsen offers a complete solution for the overhaul of your hydraulic equipment and power units. Decades of hard earned experience in the mining and manufacturing sectors have prepared our engineers with the equipment-specific knowledge and industry relationships essential to effectively and accurately project manage your overhaul.

Shut-Down Services and Proactive Maintenance

Berendsen has extensive experience in the maintenance of industrial hydraulic systems, process equipment, mobile equipment and lubrication systems. Our inducted technicians play a key role in the ongoing maintenance of hydraulic systems and equipment on mine sites, manufacturing plants and other industrial installations across Australia. Maintenance programs are tailored and flexible to meet the changing requirements of clients.

OUR REPAIR AND MAINTENANCE SERVICES



Emergency Breakdown Response

Berendsen understands that unscheduled shut-downs as a result of hydraulic system failure are a huge point of concern for any production-orientated business. Therefore the concept of the mobile hydraulic service workshop was devised, to act as a hydraulic ambulance, travelling to you to get your hydraulic system up and running again in the shortest possible time.

Our fully equipped service fleets are equipped with the tools and critical spares needed to rectify common problems, on-site, in the quickest possible timeframe.

We offer competitive labour rates for experienced, specialist hydraulic technicians and are committed to proactively identify and recommend continuous improvements to avoid reoccurrences of equipment failure.

Industry Experience

OPEN CUT MINING



LONGWALL MINING



MANUFACTURING



CONSTRUCTION



DEFENCE



ENERGY



AGRICULTURE



MATERIALS HANDLING



WASTE & RECYCLING



Open Cut Mining

- Cylinder overhaul services for mobile mining equipment including dump trucks (front and rear struts, hoist cylinders and steering cylinders) excavators (boom, stick and bucket cylinders), bulldozers (blade lift and tilt cylinders) and blast hole drills (feed cylinders)
- Off-site repair of special purpose cylinders for fixed plant applications including stacker-reclaimers (luffing cylinders), crushers (tramp release cylinders), car dumpers (wheel lock and gripper cylinders) and filter press cylinders
- Supply of on-site hydraulic maintenance and shut-down services for fixed-plant hydraulic systems and lubrication systems including belt winders, apron feeders, cone crushers, ball mills, SAG mills and filter presses
- On-site system flushing, oil sampling and analysis
- On-site inspection and charging of accumulators
- Off-site repairs for axial piston pumps, vane pumps and radial piston motors
- Design, supply and installation of turnkey hydraulic power units and lubrications systems customised to customer requirements
- Supply of filter elements, hydraulic consumables and spare parts

OUR INDUSTRY EXPERIENCE



Longwall Mining

- Supply and refurbishment of longwall mining cylinders including leg cylinders, DA rams, base lift cylinders, flipper cylinders and side shield cylinders
- Supply and repair of cylinders for development equipment including feed cylinders, shear cylinders, boom cylinders, steering cylinders and bucket lift cylinders
- Design, supply and installation of turnkey hydraulic systems for special purpose underground mining applications
- Equipment overhaul services for underground mining equipment including roof supports, gas drainage drill rigs, roof bolters, shuttle cars and man cars
- Manufacture and supply of longwall filter stations
- Supply of filter elements, filter bags, hydraulic consumables and spare parts



Manufacturing

- Supply and refurbishment of special purpose, heavy-duty cylinders for use in industrial applications including blast furnaces, casters, rolling mills, coilers, slitters, finishing mills, coke ovens, hydraulic presses and extrusion presses
- Design, supply and installation of turnkey hydraulic systems, customised to customer requirements
- Supply and installation of seamless steel tube or steel pipe
- Off-site repairs and testing of industrial piston pumps and high pressure vane pumps
- Supply of skilled hydraulic technicians for on-site maintenance and troubleshooting
- On-site system flushing, oil sampling and analysis
- On-site inspection and charging of accumulators

OUR INDUSTRY EXPERIENCE



Construction

- Cylinder overhaul services for construction equipment including dump trucks, excavators, graders, bulldozers, compactors, backhoes, asphalt pavers, crane trucks and piling machines
- On-site hydraulic maintenance and shut-down services for fixed-plant hydraulic systems and lubrication systems including, brick making plants, kilns, jaw crushers, bailers, batching plants, saw mills, hydraulic drives and hydraulic presses
- On-site inspection and charging of accumulators
- Transmission pump and motor repairs for concrete agitators
- On-site hydraulic system flushing, oil sampling and analysis
- Off-site repairs for axial piston pumps, vane pumps and radial piston motors
- Design, supply and installation of turnkey hydraulic systems tailored to customer requirements



Defence

- Design and manufacture of special-purpose cylinders
- Off-site cylinder overhaul services
- On-site hydraulic maintenance services for laboratory testing systems
- On-site system flushing, oil sampling and analysis
- Refurbishment, calibration and certification of hydraulic training systems
- Design, manufacture and supply of custom hydraulic manifolds
- Design, manufacture and installation of turnkey hydraulic systems in accordance with customer requirements
- Supply of pumps, valves and rotary actuators

OUR INDUSTRY EXPERIENCE



Energy

- Cylinder overhaul services for coal fired power generation plants including slurry pumping cylinders and pulveriser cylinders
- On-site hydraulic maintenance and shut-down services for fixed-plant hydraulic systems and lubrication systems
- Routine hydraulic maintenance service for elevated work platforms
- Off-site repairs for axial piston pumps, vane pumps and radial piston motors
- On-site inspection and charging of accumulators
- On-site system flushing, oil sampling and analysis
- Manufacture and supply of stainless steel cylinders, power units and control systems for hydro-electric power generation
- Supply of filter elements, hydraulic consumables and spare parts



Agriculture

- Supply of low speed, high torque orbital motors used on agricultural implements and machinery
- Supply of standard agricultural cylinders and phasing cylinders
- Supply of cylinder overhaul services for heavy-duty agricultural applications including hay pressing plants, cotton gins and sugar mills
- Cylinder repair services for forestry equipment
- On-site hydraulic maintenance and shut-down services for sugar mills, hay plants and cotton gins
- Off-site repairs for axial piston pumps, vane pumps and radial piston motors commonly used on cane harvesters and wheat harvesters
- Design, supply and installation of product packages for bespoke agricultural machinery and implements including sowing and harvesting equipment, crop spraying equipment, baggers, spreaders and augers
- Supply of filter elements, hydraulic consumables and spare parts

OUR INDUSTRY EXPERIENCE



Materials Handling

- Cylinder overhaul services for materials handling equipment including forklift trucks, truck cranes, tower cranes, port cranes, container handling equipment, aircraft ground handling equipment, skip-bin trucks, tip trucks and hook-trucks
- On-site hydraulic system flushing, oil sampling and analysis
- Off-site repairs for axial piston pumps, vane pumps and radial piston motors
- On-site inspection and charging of accumulators
- Design, supply and installation of turnkey hydraulic systems, tailored to customer requirements
- Supply of filter elements, hydraulic consumables and spare parts



Waste & Recycling

- Cylinder overhaul services and on-site hydraulic maintenance for waste recycling equipment including baling presses, hydraulic shears, metal shredders, hydraulic grabs, stationary compactors and classifying/grading equipment
- Cylinder repair services for mobile waste handling equipment including skip-bin trucks, tip trucks, and hook-trucks
- On-site hydraulic system flushing, oil sampling and analysis
- Off-site repairs for axial piston pumps, vane pumps and radial piston motors
- On-site inspection and charging of accumulators
- Design, supply and installation of turnkey hydraulic systems, tailored to customer requirements
- Supply of filter elements, hydraulic consumables and spare parts

Adelaide
08 7221 0300
1/9 Rosberg Rd, Wingfield SA 5013

Brisbane
07 3120 3200
20 Bernoulli St, Richlands, QLD 4077

Bundaberg
07 4181 0300
8 Kay McDuff Drive, Bundaberg, QLD 4670

Mackay
07 4999 5400
229 Boundary Rd, Mackay, QLD 4740

Melbourne
03 9760 5000
7 London Dr, Bayswater, VIC 3153

Newcastle
02 4915 1800
10-18 Carbine Cl, Wallsend, NSW 2287

Perth
08 9353 1066
2/33 Colquhoun Rd, Perth Airport, WA 6105

Sydney
02 9765 8888
1-4 Denoci Cl, Wetherill Park, NSW 2164

Wollongong
02 4298 4000
6-8 Brady St, Berkeley, NSW 2506

VISIT THE BERENDSEN FLUID POWER WEBSITE FOR MORE INFORMATION

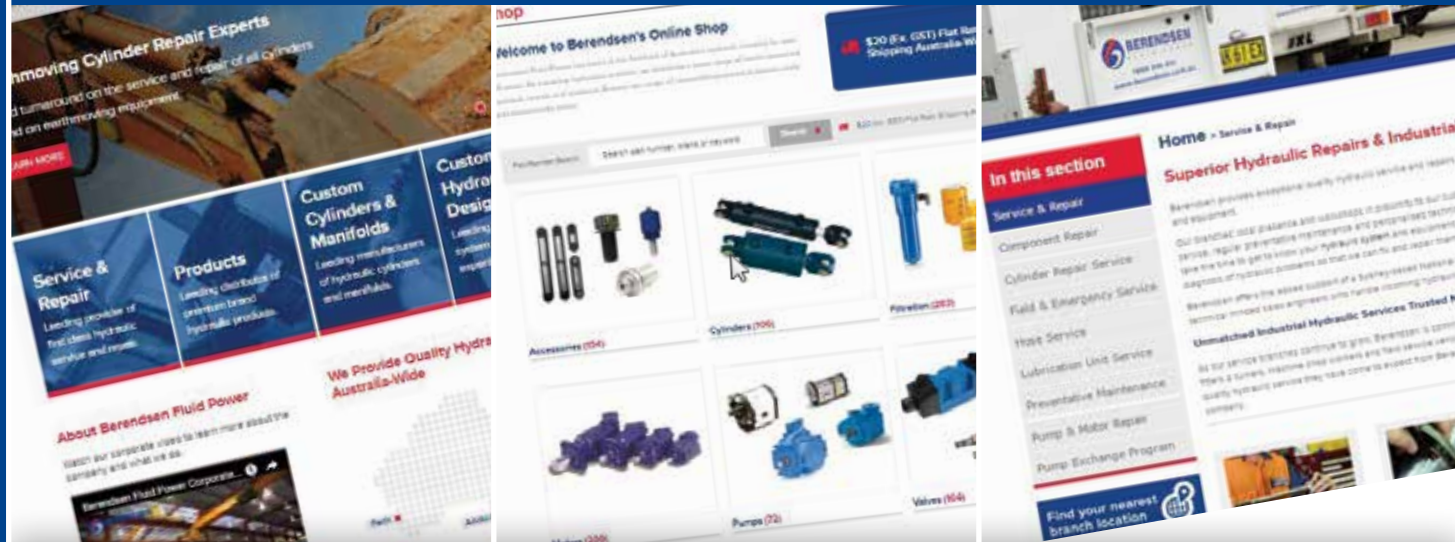

Learn more about how Berendsen can help with all your hydraulic needs, big and small.

Shop our range of industry leading brands and products.

Learn more about our custom design and manufacturing capabilities.

www.berendsen.com.au | 1800 814 411

Berendsen Fluid Power Pty Ltd - ABN 29 058 390 382